

1 PULT ZA IZDAVANJE LIJEKOVA

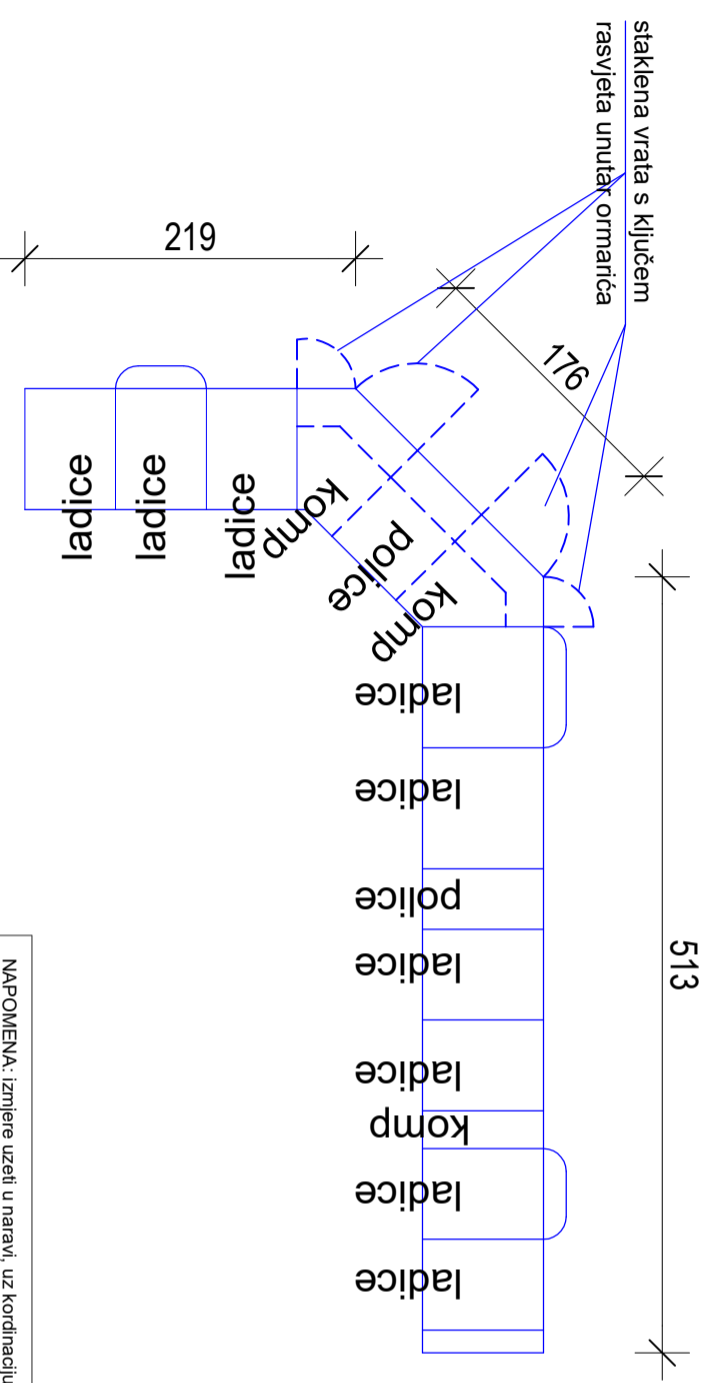

TLOCRT

NAPOMENA: izmjere uzeti u naravi, uz koordinaciju s investitorom i izvođačem radova na uređenju prostora.

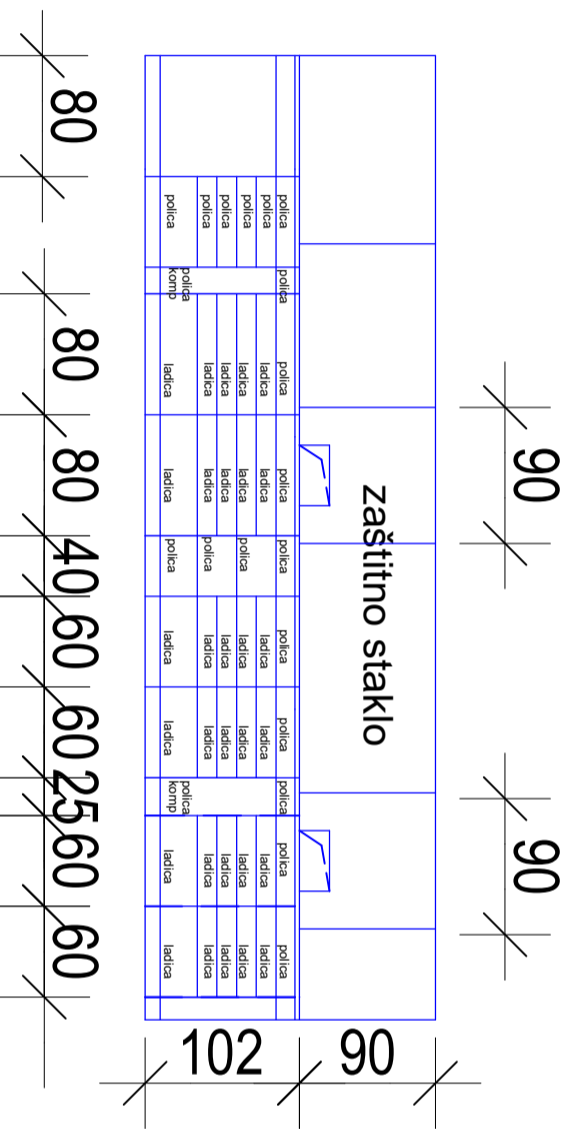

NACRT  
unutarnja strana



## 2 RETROPULT

KPL 1

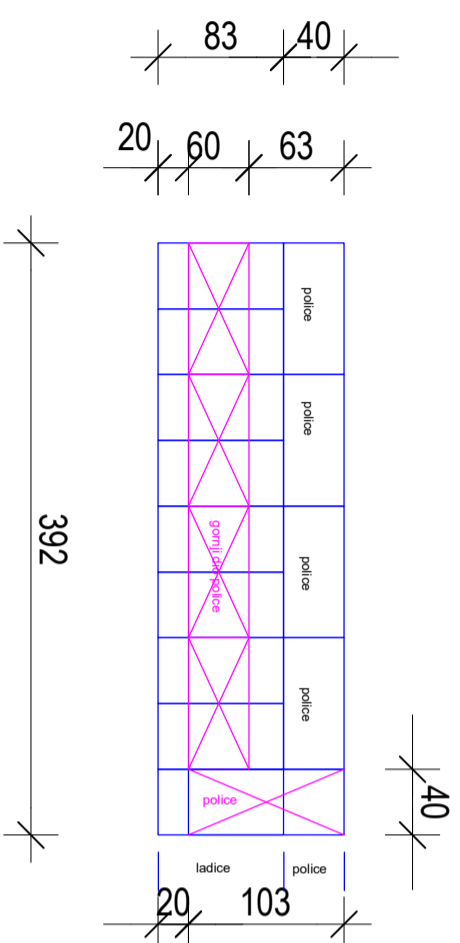

TLOCRT

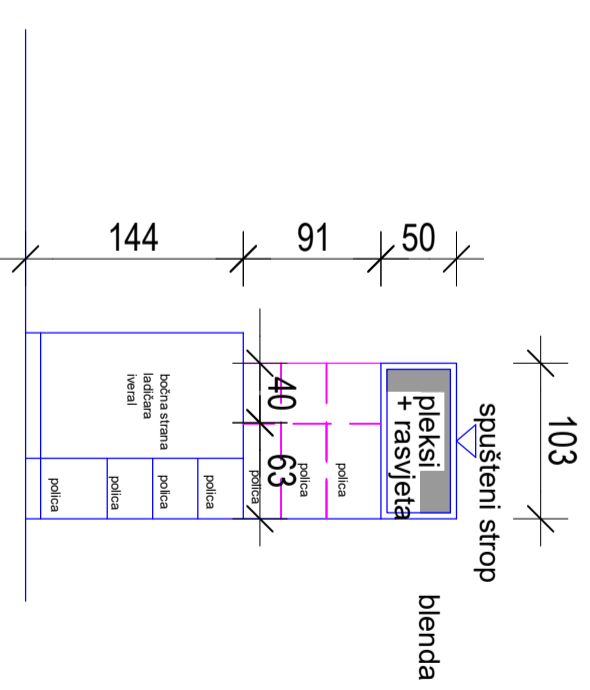

BOKOCRT

NAPOMENA: izmjere uzeti u naravi, uz koordinaciju s investitorom i izvođačem radova na uređenju prostora.

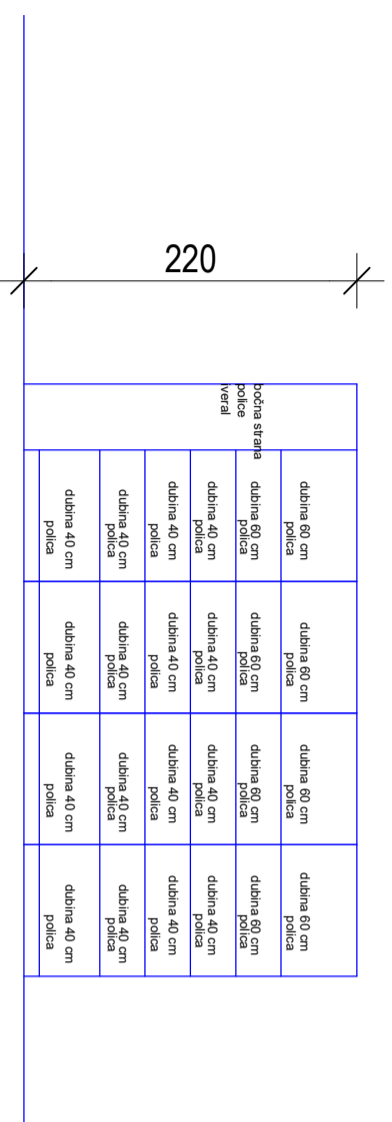
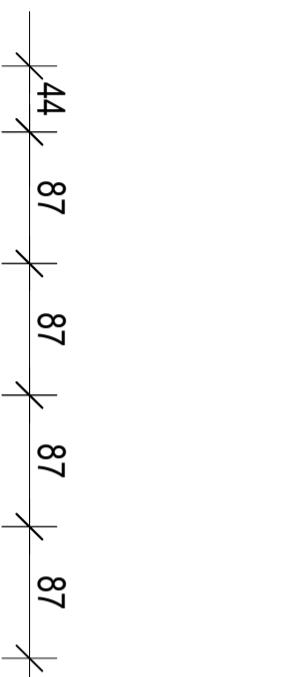

NACRT STRAŽNJA STRANA

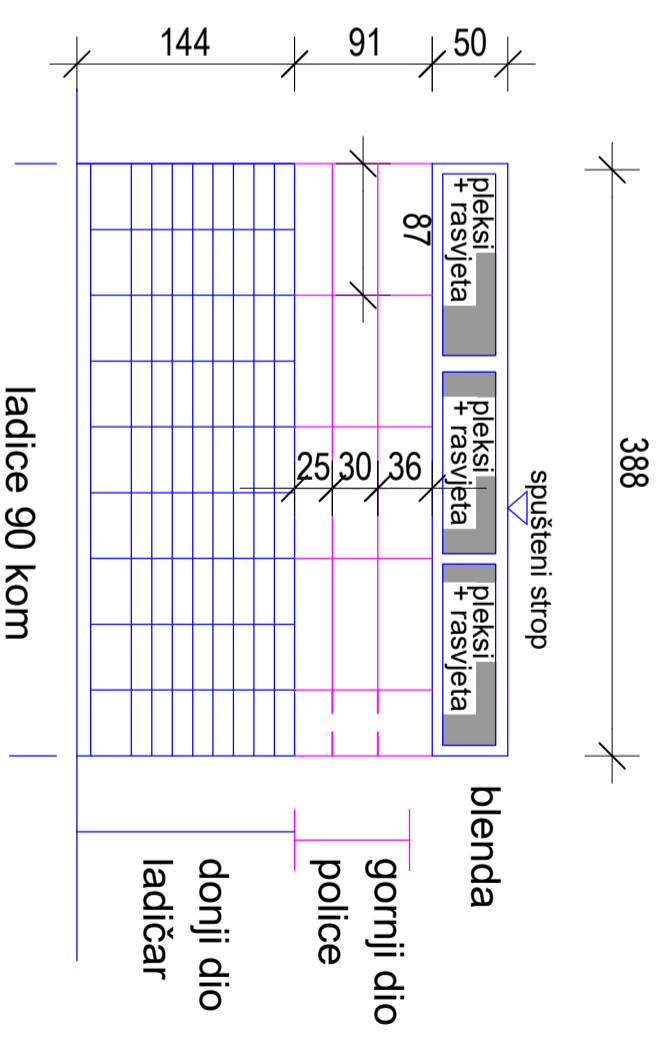

NACRT PREDNJA STRANA

### ③ ORMAR ZA KOZMETIKU kom 8

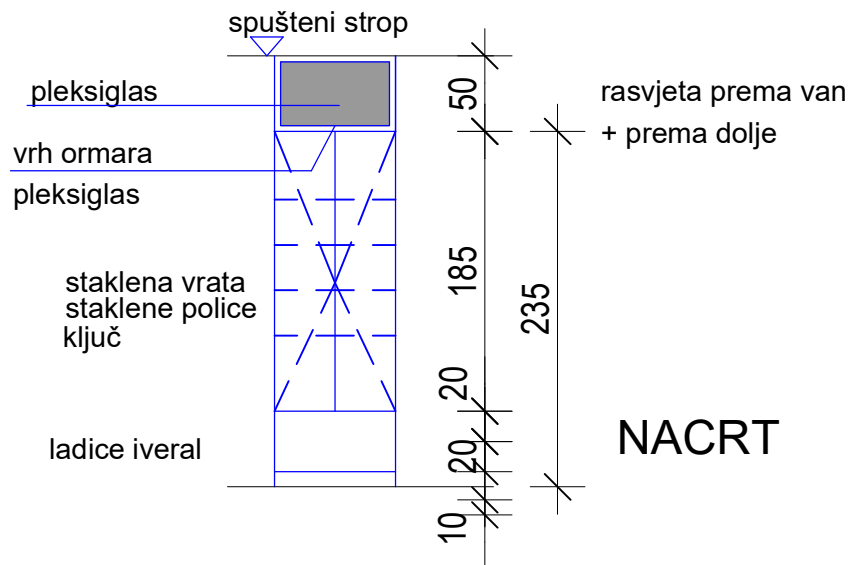

NAPOMENA: izmjere uzeti u naravi, uz kordinaciju s investitorom i izvođačem radova na uređenju prostora.

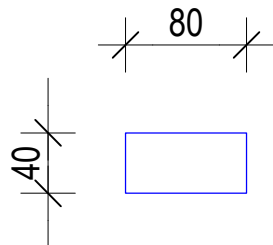

4

# STALAŽA ZA SKLADIŠTE

kom 7

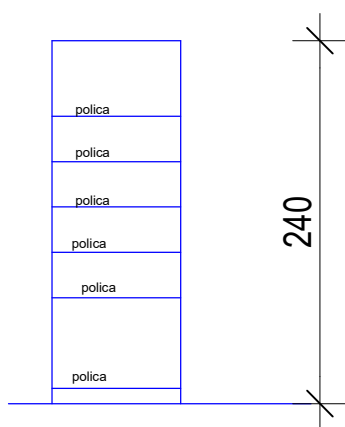

NACRT

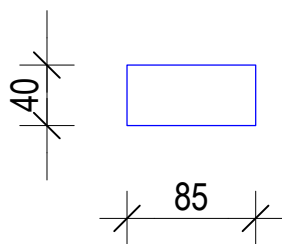

TLOCRT

5 STALAŽA ZA  
SKLADIŠTE  
kom 10

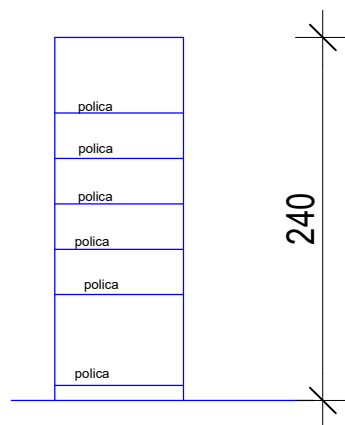

NACRT

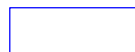
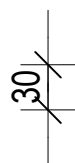

TLOCRT

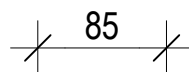

# ⑥ LABORATORIJ KPL 1

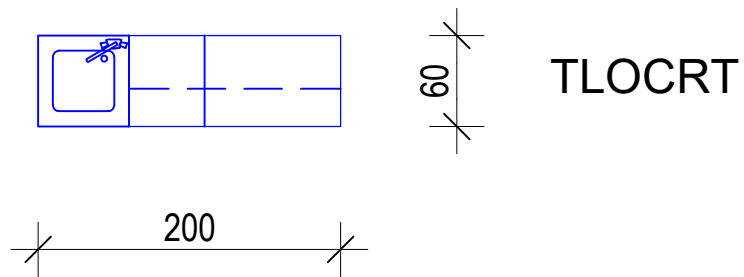

## NACRT

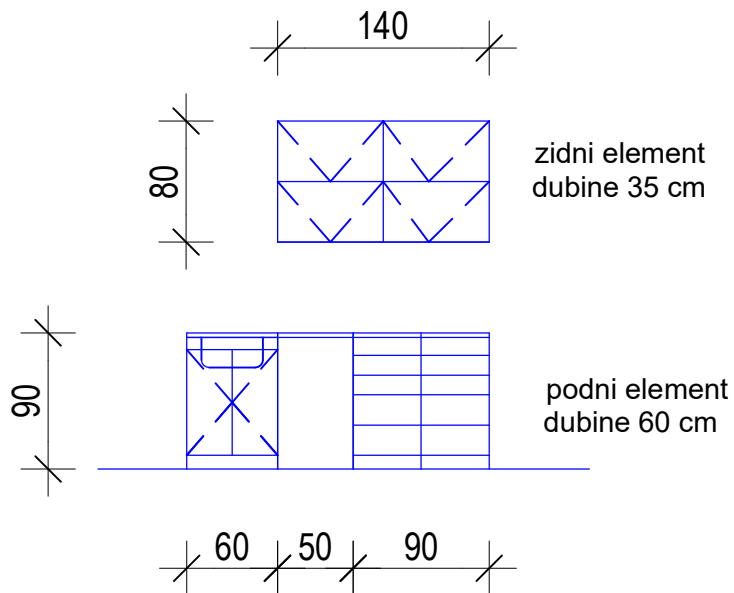

# 7 LABORATORIJ

## KPL 1

120



60

TLOCRT

NACRT

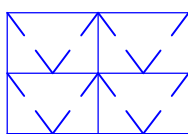

80

zidni element  
dubine 35 cm

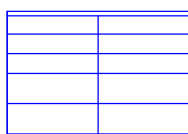

60  
90

podni element  
dubine 60 cm

120

# 8 LABORATORIJ

## kom 1

120

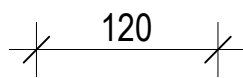

80

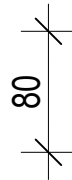

TLOCRT

NACRT

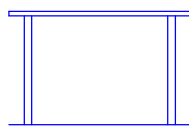

75

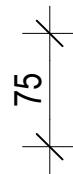

radni stol